

Permanent magnets ensure secure holding of loads

KITO LIFTING MAGNET



Allows you to lift both flat and round steel with one unit



Switch lever

Latch

This locks the switch lever to maintain the hold.

Check the video!



In this design, the magnetic force does not remain on the contact surface when the product is in the OFF condition, and it will not pick even a small paper clip up. This also allows for easy load removal.

POINT 1

Due to the use of permanent magnets, loads are securely maintained even if an electrical power outage occurs

POINT 2

Secure hold using four magnetic poles

POINT 3

Lineup of seven types with capacities from 80kg to 1.6t

In contrast to typical lifting magnets which have two magnetic poles, KITO's Lifting Magnets incorporate four poles. This allows loads to be securely held. The shape of the contact surface incorporates a V-shaped groove which enables the magnetic force to effectively flow to the curved surface of round steel.

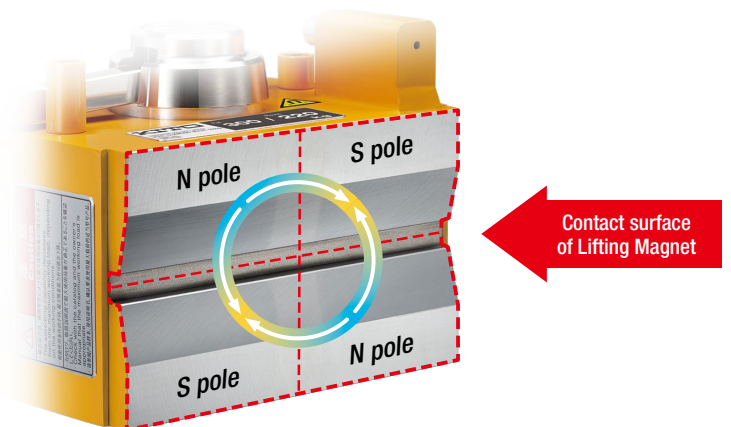

Selection of a type for use Lifting Magnet

Multiply the weight of the load by the correction coefficients obtained from the load condition and the usage condition. And select a Lifting Magnet with sufficient maximum working load required to safely lift the load.

- The load which can be lifted by the Lifting Magnet under an ideal condition is called "maximum lifting capacity."
"Maximum working load" is defined as one-third of the maximum lifting capacity.

Selection conditions

① Weight of the load

② Conditions of a load

Based on the condition of a load, identify the effective holding force from figures 1 to 6 and calculate the correction coefficient. For example, the corrective coefficient is 1/0.8 when the effective holding force is 80%.

③ Usage conditions

Determine the correction coefficient by considering factors such as the load balance and the load swing. In the general usage condition (where there is no load swing or vibration), the correction coefficient should be set to 1.1 at minimum. For an application where jogging or shock loading occurs, set the correction coefficient with a sufficient margin.

Selection example

This example shows the load condition of heat-treated S45C flat steel in general usage conditions which is 100kg in weight, 30mm in thickness, with surface finish, without coating and without gap.

Weight of Material a lifted load	Conditions of a lifted load	Fig. 1	Fig. 2	Fig. 3	Fig. 4	Fig. 5	Fig. 6	Usage conditions
		Material	Plate thickness	Diameter of round steel	Surface finishing	Coating and plating	Gap	
100kg	Correction coefficient	1/0.8	1/1	—	1/0.95	—	—	1.1
		S45C heat treatment	30mm	—	25 12.5	—	—	General

•KRD16 or larger is the proper selection in this case as the calculated maximum working load is $100 \times 1/0.8 \times 0.95 \times 1.1 = 144.7\text{kg}$.

Operation conditions

- 1. Objects lifted**
Steel plate, shaped steel, round steel and machined steel parts.
Holding force is decreased when handling parts with plate thickness of less than 25mm. Non-magnetic materials such as aluminum, stainless steel, brass, etc. cannot be lifted.
- 2. Sealability**
Internal use only. Not water-proof.
- 3. Temperature range**
-20°C~+50°C
- 4. Humidity**
85% RH or less, with no condensation.

[Fig. 1] Difference in holding force due to material (%)

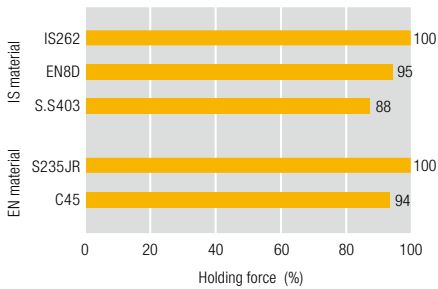

When intending to use materials other than those described above, please contact KITO for information.

[Fig. 2] Difference in holding force due to plate thickness (%)

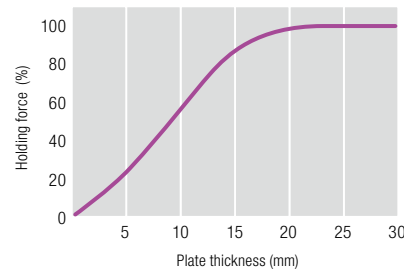

[Fig. 3] Difference in holding force due to diameter of round steel (%)

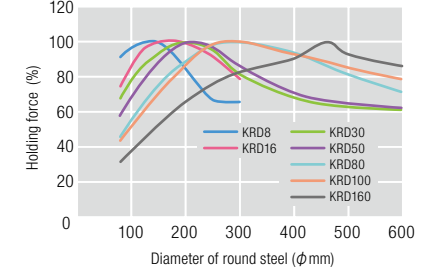

[Fig. 4] Difference in holding force due to surface finishing (%)

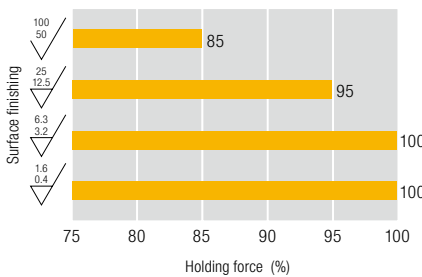

[Fig. 5] Difference in holding force due to coating and plating (%)

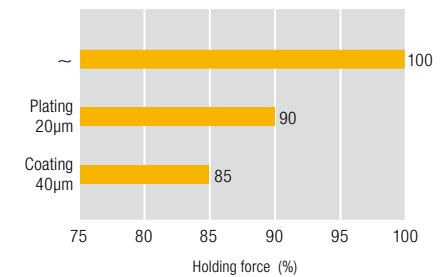

[Fig. 6] Difference in holding force due to gap (%)

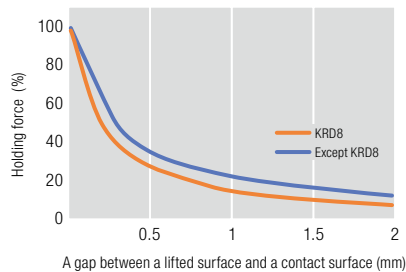

Specifications/Dimensions

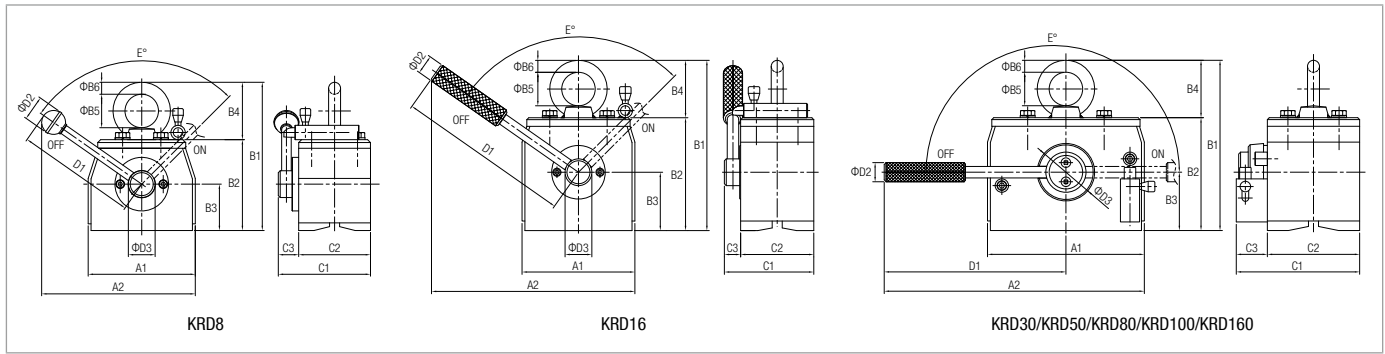

Code	Maximum working load (kg)		Net weight (kg)	Dimensions (mm)														
	Flat Steel	Round Steel		A1	A2	B1	B2	B3	B4	B5	B6	C1	C2	C3	D1	D2	D3	E
KRD8	80	60 (φ120)	6	112	160	155	95	48.5	60	35	12.5	96.4	75.1	21.3	125	25	28	100
KRD16	160	120 (φ160)	8	118	212	178	118	61	60	35	12.5	93.5	76.5	17	182	20	28	100
KRD30	300	220 (φ200)	15	164	272	178	118	61	60	35	12.5	129	96.5	32.5	190	20	60	180
KRD50	500	360 (φ200)	25	204	317	218	147	75	71	40	16	145.5	113	32.5	215	20	60	180
KRD80	800	600 (φ300)	40	262	401	263	173	88	90	50	20	160	117	43	270	22	75	180
KRD100	1000	750 (φ300)	54	283	441	307	197	101	110	60	25	170	127	43	300	22	75	180
KRD160	1600	1200 (φ460)	101	364	600	379.5	248	125	131.5	70	31.5	200	145	55	418	28	94	180

•Round steel applicable range: For KRD8 or KRD16, diameters range from 80 to 300mm. For KRD30, KRD50, KRD80, KRD100 or KRD160, diameters range from 80 to 600mm.

Select from seven models with maximum working loads from 80kg to 1.6t.

NEW!



KITO offers everything required for lifting, from cranes and hoists to all kinds of below-the-hook devices

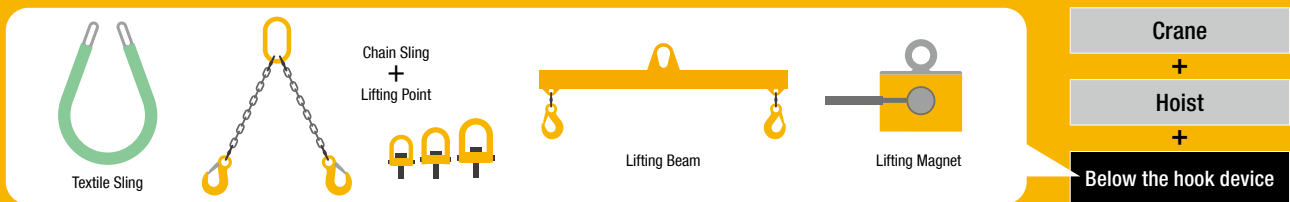

- The functions and performance of the products mentioned in the catalog have been designed based on the related regulations and standards. If they are used for other than their intended purposes such as being integrated into your equipment, we will not take any responsibility for accidents attributable to their unintended usages as well as guarantee their performance and functions. Never remodel our products.
- When you want to use our products for special purposes, consult us in advance.
- The products in this catalog are made in Korea.
- When you want to export our products, consult us in advance. There are different standards and regulations from one destination to another.
- It is prohibited to reprint, copy or divert all the information in this catalog (product patents, trademarks, photos, designs, copies, illustrations, etc.) without our consent.
- The specifications in this catalog are partly subject to change without prior notice.
- Product specifications may vary depending on the country. For more details please contact the nearest KITO dealer.

KITO CORPORATION

SHINJUKU NS Bldg. 9F, 2-4-1 Nishi-Shinjuku, Shinjuku-ku,
Tokyo 163-0809 JAPAN
TEL: +81-3-5908-0180 FAX: +81-3-5908-0189
E-mail: overseas@kito.co.jp
www.kito.co.jp

Distributed by:



2023.3(SA.H)